

Programmable Controller

**MELSEC iQ-R**  
series

## MELSEC iQ-R Channel Isolated Pulse Input Module User's Manual (Startup)

---

-RD60P8-G



# SAFETY PRECAUTIONS



---

(Read these precautions before using this product.)

Before using this product, please read this manual and the relevant manuals carefully and pay full attention to safety to handle the product correctly.

The precautions given in this manual are concerned with this product only. For the safety precautions of the programmable controller system, refer to the MELSEC iQ-R Module Configuration Manual.

In this manual, the safety precautions are classified into two levels: "⚠️ WARNING" and "⚠️ CAUTION".

 <b>WARNING</b>	Indicates that incorrect handling may cause hazardous conditions, resulting in death or severe injury.
 <b>CAUTION</b>	Indicates that incorrect handling may cause hazardous conditions, resulting in minor or moderate injury or property damage.

Under some circumstances, failure to observe the precautions given under "⚠️ CAUTION" may lead to serious consequences.

Observe the precautions of both levels because they are important for personal and system safety.

Make sure that the end users read this manual and then keep the manual in a safe place for future reference.

## [Design Precautions]

---

### **WARNING**

---

- Configure safety circuits external to the programmable controller to ensure that the entire system operates safely even when a fault occurs in the external power supply or the programmable controller. Failure to do so may result in an accident due to an incorrect output or malfunction.
    - (1) Emergency stop circuits, protection circuits, and protective interlock circuits for conflicting operations (such as forward/reverse rotations or upper/lower limit positioning) must be configured external to the programmable controller.
    - (2) When the programmable controller detects an abnormal condition, it stops the operation and all outputs are:
      - Turned off if the overcurrent or overvoltage protection of the power supply module is activated.
      - Held or turned off according to the parameter setting if the self-diagnostic function of the CPU module detects an error such as a watchdog timer error.
    - (3) All outputs may be turned on if an error occurs in a part, such as an I/O control part, where the CPU module cannot detect any error. To ensure safety operation in such a case, provide a safety mechanism or a fail-safe circuit external to the programmable controller. For a fail-safe circuit example, refer to "General Safety Requirements" in the MELSEC iQ-R Module Configuration Manual.
    - (4) Outputs may remain on or off due to a failure of a component such as a relay and transistor in an output circuit. Configure an external circuit for monitoring output signals that could cause a serious accident.
  - In an output circuit, when a load current exceeding the rated current or an overcurrent caused by a load short-circuit flows for a long time, it may cause smoke and fire. To prevent this, configure an external safety circuit, such as a fuse.
  - Configure a circuit so that the programmable controller is turned on first and then the external power supply. If the external power supply is turned on first, an accident may occur due to an incorrect output or malfunction.
  - For the operating status of each station after a communication failure, refer to manuals relevant to the network. Incorrect output or malfunction due to a communication failure may result in an accident.
  - When connecting an external device with a CPU module or intelligent function module to modify data of a running programmable controller, configure an interlock circuit in the program to ensure that the entire system will always operate safely. For other forms of control (such as program modification, parameter change, forced output, or operating status change) of a running programmable controller, read the relevant manuals carefully and ensure that the operation is safe before proceeding. Improper operation may damage machines or cause accidents.
-

## [Design Precautions]

---

### **WARNING**

- Especially, when a remote programmable controller is controlled by an external device, immediate action cannot be taken if a problem occurs in the programmable controller due to a communication failure. To prevent this, configure an interlock circuit in the program, and determine corrective actions to be taken between the external device and CPU module in case of a communication failure.
  - Do not write any data to the "system area" and "write-protect area" of the buffer memory in the module. Also, do not use any "use prohibited" signals as an output signal from the CPU module to each module. Doing so may cause malfunction of the programmable controller system. For the "system area", "write-protect area", and the "use prohibited" signals, refer to the user's manual for the module used.
  - If a communication cable is disconnected, the network may be unstable, resulting in a communication failure of multiple stations. Configure an interlock circuit in the program to ensure that the entire system will always operate safely even if communications fail. Failure to do so may result in an accident due to an incorrect output or malfunction.
  - To maintain the safety of the programmable controller system against unauthorized access from external devices via the network, take appropriate measures. To maintain the safety against unauthorized access via the Internet, take measures such as installing a firewall.
- 

## [Design Precautions]

---

### **CAUTION**

- Do not install the control lines or communication cables together with the main circuit lines or power cables. Keep a distance of 150mm or more between them. Failure to do so may result in malfunction due to noise.
  - During control of an inductive load such as a lamp, heater, or solenoid valve, a large current (approximately ten times greater than normal) may flow when the output is turned from off to on. Therefore, use a module that has a sufficient current rating.
  - After the CPU module is powered on or is reset, the time taken to enter the RUN status varies depending on the system configuration, parameter settings, and/or program size. Design circuits so that the entire system will always operate safely, regardless of the time.
  - Do not power off the programmable controller or reset the CPU module while the settings are being written. Doing so will make the data in the flash ROM and SD memory card undefined. The values need to be set in the buffer memory and written to the flash ROM and SD memory card again. Doing so also may cause malfunction or failure of the module.
  - When changing the operating status of the CPU module from external devices (such as the remote RUN/STOP functions), select "Do Not Open by Program" for "Opening Method" of "Module Parameter". If "Open by Program" is selected, an execution of the remote STOP function causes the communication line to close. Consequently, the CPU module cannot reopen the line, and external devices cannot execute the remote RUN function.
-

## [Installation Precautions]

---

### **WARNING**

- Shut off the external power supply (all phases) used in the system before mounting or removing the module. Failure to do so may result in electric shock or cause the module to fail or malfunction.
- 

## [Installation Precautions]

---

### **CAUTION**

- Use the programmable controller in an environment that meets the general specifications in the Safety Guidelines included with the base unit. Failure to do so may result in electric shock, fire, malfunction, or damage to or deterioration of the product.
  - To mount a module, place the concave part(s) located at the bottom onto the guide(s) of the base unit, and push in the module until the hook(s) located at the top snaps into place. Incorrect interconnection may cause malfunction, failure, or drop of the module.
  - To mount a module with no module fixing hook, place the concave part(s) located at the bottom onto the guide(s) of the base unit, push in the module, and fix it with screw(s). Incorrect interconnection may cause malfunction, failure, or drop of the module.
  - When using the programmable controller in an environment of frequent vibrations, fix the module with a screw.
  - Tighten the screws within the specified torque range. Undertightening can cause drop of the screw, short circuit, or malfunction. Overtightening can damage the screw and/or module, resulting in drop, short circuit, or malfunction.
  - When using an extension cable, connect it to the extension cable connector of the base unit securely. Check the connection for looseness. Poor contact may cause malfunction.
  - When using an SD memory card, fully insert it into the SD memory card slot. Check that it is inserted completely. Poor contact may cause malfunction.
  - Securely insert an extended SRAM cassette or a battery-less option cassette into the cassette connector of the CPU module. After insertion, close the cassette cover and check that the cassette is inserted completely. Poor contact may cause malfunction.
  - Do not directly touch any conductive parts and electronic components of the module, SD memory card, extended SRAM cassette, battery-less option cassette, or connector. Doing so can cause malfunction or failure of the module.
-

## [Wiring Precautions]

---

### **WARNING**

- Shut off the external power supply (all phases) used in the system before installation and wiring. Failure to do so may result in electric shock or cause the module to fail or malfunction.
  - After installation and wiring, attach a blank cover module (RG60) to each empty slot and an included extension connector protective cover to the unused extension cable connector before powering on the system for operation. Failure to do so may result in electric shock.
- 

## [Wiring Precautions]

---

### **CAUTION**

- Individually ground the FG and LG terminals of the programmable controller with a ground resistance of 100 ohms or less. Failure to do so may result in electric shock or malfunction.
  - Use applicable solderless terminals and tighten them within the specified torque range. If any spade solderless terminal is used, it may be disconnected when the terminal screw comes loose, resulting in failure.
  - Check the rated voltage and signal layout before wiring to the module, and connect the cables correctly. Connecting a power supply with a different voltage rating or incorrect wiring may cause fire or failure.
  - Connectors for external devices must be crimped or pressed with the tool specified by the manufacturer, or must be correctly soldered. Incomplete connections may cause short circuit, fire, or malfunction.
  - Securely connect the connector to the module. Poor contact may cause malfunction.
  - Do not install the control lines or communication cables together with the main circuit lines or power cables. Keep a distance of 150mm or more between them. Failure to do so may result in malfunction due to noise.
  - Place the cables in a duct or clamp them. If not, dangling cables may swing or inadvertently be pulled, resulting in malfunction or damage to modules or cables.  
In addition, the weight of the cables may put stress on modules in an environment of strong vibrations and shocks.  
Do not clamp the extension cables with the jacket stripped. Doing so may change the characteristics of the cables, resulting in malfunction.
  - Check the interface type and correctly connect the cable. Incorrect wiring (connecting the cable to an incorrect interface) may cause failure of the module and external device.
  - Tighten the terminal screws or connector screws within the specified torque range. Undertightening can cause drop of the screw, short circuit, fire, or malfunction. Overtightening can damage the screw and/or module, resulting in drop, short circuit, fire, or malfunction.
  - When disconnecting the cable from the module, do not pull the cable by the cable part. For the cable with connector, hold the connector part of the cable. For the cable connected to the terminal block, loosen the terminal screw. Pulling the cable connected to the module may result in malfunction or damage to the module or cable.
  - Prevent foreign matter such as dust or wire chips from entering the module. Such foreign matter can cause a fire, failure, or malfunction.
  - A protective film is attached to the top of the module to prevent foreign matter, such as wire chips, from entering the module during wiring. Do not remove the film during wiring. Remove it for heat dissipation before system operation.
-

## [Wiring Precautions]

---

### **CAUTION**

- Programmable controllers must be installed in control panels. Connect the main power supply to the power supply module in the control panel through a relay terminal block. Wiring and replacement of a power supply module must be performed by qualified maintenance personnel with knowledge of protection against electric shock. For wiring, refer to the MELSEC iQ-R Module Configuration Manual.
  - For Ethernet cables to be used in the system, select the ones that meet the specifications in the user's manual for the module used. If not, normal data transmission is not guaranteed.
  - Ground the shielded cables with a ground resistance of 100 ohm or less. Failure to do so may cause malfunction.
- 

## [Startup and Maintenance Precautions]

---

### **WARNING**

- Do not touch any terminal while power is on. Doing so will cause electric shock or malfunction.
  - Correctly connect the battery connector. Do not charge, disassemble, heat, short-circuit, solder, or throw the battery into the fire. Also, do not expose it to liquid or strong shock. Doing so will cause the battery to produce heat, explode, ignite, or leak, resulting in injury and fire.
  - Shut off the external power supply (all phases) used in the system before cleaning the module or retightening the terminal screws, connector screws, or module fixing screws. Failure to do so may result in electric shock.
-



## [Startup and Maintenance Precautions]

---

### CAUTION

- When connecting an external device with a CPU module or intelligent function module to modify data of a running programmable controller, configure an interlock circuit in the program to ensure that the entire system will always operate safely. For other forms of control (such as program modification, parameter change, forced output, or operating status change) of a running programmable controller, read the relevant manuals carefully and ensure that the operation is safe before proceeding. Improper operation may damage machines or cause accidents.
  - Especially, when a remote programmable controller is controlled by an external device, immediate action cannot be taken if a problem occurs in the programmable controller due to a communication failure. To prevent this, configure an interlock circuit in the program, and determine corrective actions to be taken between the external device and CPU module in case of a communication failure.
  - Do not disassemble or modify the modules. Doing so may cause failure, malfunction, injury, or a fire.
  - Use any radio communication device such as a cellular phone or PHS (Personal Handy-phone System) more than 25cm away in all directions from the programmable controller. Failure to do so may cause malfunction.
  - Shut off the external power supply (all phases) used in the system before mounting or removing the module. Failure to do so may cause the module to fail or malfunction.
  - Tighten the screws within the specified torque range. Undertightening can cause drop of the component or wire, short circuit, or malfunction. Overtightening can damage the screw and/or module, resulting in drop, short circuit, or malfunction.
  - After the first use of the product, do not perform each of the following operations more than 50 times (IEC 61131-2/JIS B 3502 compliant).  
Exceeding the limit may cause malfunction.
    - Mounting/removing the module to/from the base unit
    - Inserting/removing the extended SRAM cassette or battery-less option cassette to/from the CPU module
    - Mounting/removing the terminal block to/from the module
  - After the first use of the product, do not insert/remove the SD memory card to/from the CPU module more than 500 times. Exceeding the limit may cause malfunction.
  - Do not touch the metal terminals on the back side of the SD memory card. Doing so may cause malfunction or failure of the module.
  - Do not touch the integrated circuits on the circuit board of an extended SRAM cassette or a battery-less option cassette. Doing so may cause malfunction or failure of the module.
  - Do not drop or apply shock to the battery to be installed in the module. Doing so may damage the battery, causing the battery fluid to leak inside the battery. If the battery is dropped or any shock is applied to it, dispose of it without using.
  - Startup and maintenance of a control panel must be performed by qualified maintenance personnel with knowledge of protection against electric shock. Lock the control panel so that only qualified maintenance personnel can operate it.
  - Before handling the module, touch a conducting object such as a grounded metal to discharge the static electricity from the human body. Failure to do so may cause the module to fail or malfunction.
-

## [Operating Precautions]

---

### CAUTION

- When changing data and operating status, and modifying program of the running programmable controller from an external device such as a personal computer connected to an intelligent function module, read relevant manuals carefully and ensure the safety before operation. Incorrect change or modification may cause system malfunction, damage to the machines, or accidents.
  - Do not power off the programmable controller or reset the CPU module while the setting values in the buffer memory are being written to the flash ROM in the module. Doing so will make the data in the flash ROM and SD memory card undefined. The values need to be set in the buffer memory and written to the flash ROM and SD memory card again. Doing so can cause malfunction or failure of the module.
- 

## [Disposal Precautions]

---

### CAUTION

- When disposing of this product, treat it as industrial waste.
  - When disposing of batteries, separate them from other wastes according to the local regulations. For details on battery regulations in EU member states, refer to the MELSEC iQ-R Module Configuration Manual.
- 

## [Transportation Precautions]

---

### CAUTION

- When transporting lithium batteries, follow the transportation regulations. For details on the regulated models, refer to the MELSEC iQ-R Module Configuration Manual.
  - The halogens (such as fluorine, chlorine, bromine, and iodine), which are contained in a fumigant used for disinfection and pest control of wood packaging materials, may cause failure of the product. Prevent the entry of fumigant residues into the product or consider other methods (such as heat treatment) instead of fumigation. The disinfection and pest control measures must be applied to unprocessed raw wood.
-

# CONDITIONS OF USE FOR THE PRODUCT

---

(1) Mitsubishi programmable controller ("the PRODUCT") shall be used in conditions;

- i) where any problem, fault or failure occurring in the PRODUCT, if any, shall not lead to any major or serious accident; and
- ii) where the backup and fail-safe function are systematically or automatically provided outside of the PRODUCT for the case of any problem, fault or failure occurring in the PRODUCT.

(2) The PRODUCT has been designed and manufactured for the purpose of being used in general industries.

MITSUBISHI SHALL HAVE NO RESPONSIBILITY OR LIABILITY (INCLUDING, BUT NOT LIMITED TO ANY AND ALL RESPONSIBILITY OR LIABILITY BASED ON CONTRACT, WARRANTY, TORT, PRODUCT LIABILITY) FOR ANY INJURY OR DEATH TO PERSONS OR LOSS OR DAMAGE TO PROPERTY CAUSED BY the PRODUCT THAT ARE OPERATED OR USED IN APPLICATION NOT INTENDED OR EXCLUDED BY INSTRUCTIONS, PRECAUTIONS, OR WARNING CONTAINED IN MITSUBISHI'S USER, INSTRUCTION AND/OR SAFETY MANUALS, TECHNICAL BULLETINS AND GUIDELINES FOR the PRODUCT.

("Prohibited Application")

Prohibited Applications include, but not limited to, the use of the PRODUCT in;

- Nuclear Power Plants and any other power plants operated by Power companies, and/or any other cases in which the public could be affected if any problem or fault occurs in the PRODUCT.
- Railway companies or Public service purposes, and/or any other cases in which establishment of a special quality assurance system is required by the Purchaser or End User.
- Aircraft or Aerospace, Medical applications, Train equipment, transport equipment such as Elevator and Escalator, Incineration and Fuel devices, Vehicles, Manned transportation, Equipment for Recreation and Amusement, and Safety devices, handling of Nuclear or Hazardous Materials or Chemicals, Mining and Drilling, and/or other applications where there is a significant risk of injury to the public or property.

Notwithstanding the above restrictions, Mitsubishi may in its sole discretion, authorize use of the PRODUCT in one or more of the Prohibited Applications, provided that the usage of the PRODUCT is limited only for the specific applications agreed to by Mitsubishi and provided further that no special quality assurance or fail-safe, redundant or other safety features which exceed the general specifications of the PRODUCTS are required. For details, please contact the Mitsubishi representative in your region.

# INTRODUCTION

---

Thank you for purchasing the Mitsubishi Electric MELSEC iQ-R series programmable controllers.

This manual describes the specifications, procedures before operation, wiring, and programming of the relevant products listed below.

Before using this product, please read this manual and the relevant manuals carefully and develop familiarity with the functions and performance of the MELSEC iQ-R series programmable controller to handle the product correctly.

When applying the program examples provided in this manual to an actual system, ensure the applicability and confirm that it will not cause system control problems.

Please make sure that the end users read this manual.

## Point

Unless otherwise specified, this manual provides program examples in which the I/O numbers of X/Y0 to X/Y1F are assigned to the pulse input module. Assign I/O numbers when applying the program examples to an actual system. For I/O number assignment, refer to the following.

 MELSEC iQ-R Module Configuration Manual

---

## Relevant product



RD60P8-G

# COMPLIANCE WITH EMC AND LOW VOLTAGE DIRECTIVES

---

## Method of ensuring compliance



To ensure that Mitsubishi programmable controllers maintain EMC and Low Voltage Directives when incorporated into other machinery or equipment, certain measures may be necessary. Please refer to one of the following manuals.

-  MELSEC iQ-R Module Configuration Manual
-  Safety Guidelines (This manual is included with the base unit.)

The CE mark on the side of the programmable controller indicates compliance with EMC and Low Voltage Directives.

## Additional measures

To ensure that this product maintains EMC and Low Voltage Directives, please refer to one of the following manuals.

-  MELSEC iQ-R Module Configuration Manual
-  Safety Guidelines (This manual is included with the base unit.)

# CONTENTS

SAFETY PRECAUTIONS .....	1
CONDITIONS OF USE FOR THE PRODUCT .....	9
INTRODUCTION .....	10
COMPLIANCE WITH EMC AND LOW VOLTAGE DIRECTIVES .....	10
RELEVANT MANUALS .....	12
TERMS .....	12
GENERIC TERMS AND ABBREVIATIONS .....	12
<b>CHAPTER 1 PART NAMES</b>	<b>13</b>
<b>CHAPTER 2 SPECIFICATIONS</b>	<b>15</b>
2.1 Performance Specifications .....	15
<b>CHAPTER 3 FUNCTION LIST</b>	<b>17</b>
<b>CHAPTER 4 PROCEDURES BEFORE OPERATION</b>	<b>19</b>
<b>CHAPTER 5 SYSTEM CONFIGURATION</b>	<b>21</b>
<b>CHAPTER 6 INSTALLATION AND WIRING</b>	<b>23</b>
6.1 Wiring .....	23
Wiring precautions .....	23
Terminal block .....	24
Interface with external devices .....	25
6.2 External Wiring .....	26
Wiring to the terminal block .....	26
Wiring examples of source-type pulse generator .....	27
Wiring examples of sink-type pulse generator .....	28
<b>CHAPTER 7 OPERATION EXAMPLES</b>	<b>29</b>
7.1 Programming Procedure .....	29
7.2 Program Examples .....	30
<b>APPENDICES</b>	<b>34</b>
Appendix 1 External Dimensions .....	34
<b>INDEX</b>	<b>36</b>
REVISIONS .....	38
WARRANTY .....	39
TRADEMARKS .....	40

# RELEVANT MANUALS

Manual name [manual number]	Description	Available form
MELSEC iQ-R Channel Isolated Pulse Input Module User's Manual (Startup) [SH-082003ENG]	Specifications, procedures before operation, wiring, and operation examples of the pulse input module	Print book e-Manual PDF
MELSEC iQ-R Channel Isolated Pulse Input Module User's Manual (Application) [SH-082005ENG]	Functions, parameter settings, troubleshooting, I/O signals, and buffer memory of the pulse input module	Print book e-Manual PDF
MELSEC iQ-R Programming Manual (CPU Module Instructions, Standard Functions/Function Blocks) [SH-081266ENG]	Instructions for the CPU module and standard functions/function blocks	e-Manual PDF

This manual does not include detailed information on the following:

- General specifications
- Applicable CPU modules and the number of mountable modules
- Installation

For details, refer to the following.

 MELSEC iQ-R Module Configuration Manual

## Point

e-Manual refers to the Mitsubishi Electric FA electronic book manuals that can be browsed using a dedicated tool.

e-Manual has the following features:

- Required information can be cross-searched in multiple manuals.
- Other manuals can be accessed from the links in the manual.
- The hardware specifications of each part can be found from the product figures.
- Pages that users often browse can be bookmarked.
- Sample programs can be copied to an engineering tool.

# TERMS

Unless otherwise specified, this manual uses the following terms.

Term	Description
Buffer memory	Memory in an intelligent function module for storing data such as setting values and monitored values. When integrated into the CPU module, this memory refers to a memory for storing data such as setting values and monitored values of the Ethernet function, and data used for data communication of the multiple CPU system function.
Engineering tool	A tool used for setting up programmable controllers, programming, debugging, and maintenance.
Global label	A label that is valid for all the program data when multiple program data are created in the project. There are two types of global label: a module specific label (module label), which is generated automatically by GX Works3, and an optional label, which can be created for any specified device.
Module label	A label that represents one of memory areas (I/O signals and buffer memory areas) specific to each module in a given character string. For the module used, GX Works3 automatically generates this label, which can be used as a global label.
Q series-compatible mode	A mode in which the module operates with the buffer memory map converted to the equivalent one of the MELSEC-Q series
R mode	A mode in which the module operates with the buffer memory map that has been newly laid out in the MELSEC iQ-R series
Watchdog timer error	An error that occurs if the internal processing of the module is abnormal. Watchdog timer enables the module to monitor its own internal processing.

# GENERIC TERMS AND ABBREVIATIONS

Unless otherwise specified, this manual uses the following generic terms and abbreviations.

Generic term and abbreviation	Description
Pulse input module	An abbreviation for the MELSEC iQ-R channel isolated pulse input module

# 1 PART NAMES

This section describes the part names of the pulse input module.

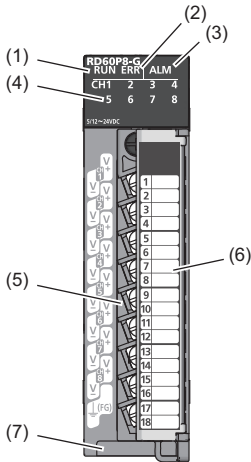

No.	Name	Description
(1)	RUN LED	Indicates the operating status of the module. On: Normal operation Flashing (400ms cycles): Selected as a module for the online module change Off: 5V power supply interrupted, watchdog timer error occurred, or module replacement allowed in the process of the online module change
(2)	ERR LED	Indicates the error status of the module.*1 On: Error occurred Off: Normal operation
(3)	ALM LED	Indicates the alarm status of the module.*1 On: Alarm occurred Off: Normal operation
(4)	CH1 to CH8 LED	Indicates the voltage application status of the pulse input terminal. On: Voltage is being applied to the pulse input terminal of CH1 to CH8. Off: No voltage is being applied to the pulse input terminal of CH1 to CH8.
(5)	Terminal block	An 18-point screw terminal block for connecting the input signal wire of the pulse generator.
(6)	Terminal block cover	Covers for preventing electric shock while the power is on
(7)	Production information marking	Shows the production information (16 digits) of the module.

\*1 For details, refer to the following.

📖 MELSEC iQ-R Channel Isolated Pulse Input Module User's Manual (Application)

# MEMO

---



# 2 SPECIFICATIONS

This chapter describes the performance specifications.

## 2.1 Performance Specifications

This section describes the performance specifications of the pulse input module.

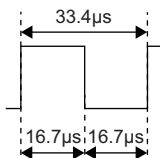
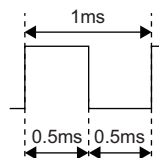
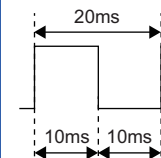
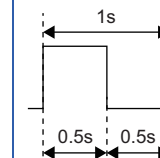
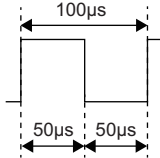
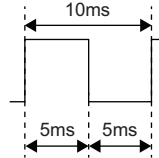
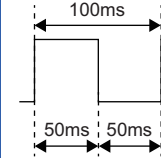
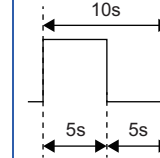
Item		Specifications							
Counting speed switch setting <sup>*1</sup>		30kpps (10k to 30kpps)	10kpps (1k to 10kpps)	1kpps (100 to 1kpps)	100pps (50 to 100pps)	50pps (10 to 50pps)	10pps (1 to 10pps)	1pps (0.1 to 1pps)	0.1pps (0.05 to 0.1pps)
Number of channels		8 channels							
Count input signal	Phase	1-phase input							
	Signal level	<ul style="list-style-type: none"> <li>• 5VDC</li> <li>• 12 to 24VDC</li> </ul>							
Counter	Counting speed (Max.) <sup>*2</sup>	30kpps	10kpps	1kpps	100pps	50pps	10pps	1pps	0.1pps
	Counting range	Sampling pulse number: 16-bit unsigned binary (0 to 32767) Accumulating count value: 32-bit unsigned binary (0 to 99999999) Input pulse value: 32-bit unsigned binary (0 to 2147483647)							
	Count type	Linear counter Ring counter							
	Minimum count pulse width (Duty ratio 50%)	■30kpps 	■1kpps 	■50pps 	■1pps 	■10kpps 	■100pps 	■10pps 	■0.1pps 
Withstand voltage		Between I/O terminals and programmable controller power supply: 500VACrms for 1 minute 1780VAC for 1 minute between channels							
Isolation resistance		Between I/O terminals and programmable controller power supply: 10MΩ or higher, at 500VDC 10MΩ or higher, at 500VDC between channels							
External interface		18-point terminal block							
Applicable wire size		0.3 to 0.75mm <sup>2</sup> (AWG22 to 18)							
Applicable solderless terminal		R1.25-3 (solderless terminal with an insulation sleeve cannot be used)							
Number of occupied I/O points		32 points (I/O assignment: Intelligent 32 points)							
Internal current consumption (5VDC)		0.72A							
External dimensions	Height	106mm (Base unit mounting side: 98mm)							
	Width	27.8mm							
	Depth	131mm							
Weight		0.23kg							

\*1 The counting speed is set in "Input filter setting" of "Module parameter".

\*2 The counting speed is affected by the rise/fall time of pulses. The countable counting speeds are described in the following table. Note that counting the pulses of long rise/fall time may result in miscounting.

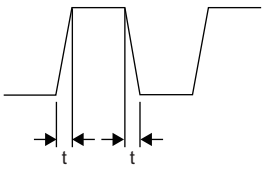
Rise/fall time	Counting speed switch setting								
	30kpps	10kpps	1kpps	100pps	50pps	10pps	1pps	0.1pps	
	t=8.4μs or less	30kpps	10kpps	1kpps	100pps	50pps	10pps	1pps	0.1pps
	t=25μs or less	10kpps	10kpps	1kpps	100pps	50pps	10pps	1pps	0.1pps
	t=250μs or less	—	1kpps	1kpps	100pps	50pps	10pps	1pps	0.1pps
	t=2.5ms or less	—	—	100pps	100pps	50pps	10pps	1pps	0.1pps
	t=5ms or less	—	—	—	50pps	50pps	10pps	1pps	0.1pps
	t=25ms or less	—	—	—	—	10pps	10pps	1pps	0.1pps
	t=250ms or less	—	—	—	—	—	1pps	1pps	0.1pps
	t=2.5s or less	—	—	—	—	—	—	0.1pps	0.1pps
	t=5s or less	—	—	—	—	—	—	—	0.05pps

# 3 FUNCTION LIST

The following table lists the functions of the pulse input module. For details on each function, refer to the following.

 MELSEC iQ-R Channel Isolated Pulse Input Module User's Manual (Application)

Item		Description
Accumulating counter	Linear counter function	Counts the input pulse from 0 to 99999999. When the input pulse exceeds the count range, an overflow is detected.
	Ring counter function	Repeatedly counts the input pulse from 0 to 99999999.
	Comparison output function	Detects that the accumulating count value exceeds the set value.
Sampling counter	Count cycle change function	Changes the sampling pulse number and the count cycle of the accumulating count value.
	Pre-scale function	Converts the pulse number by multiplying the input pulse number by an arbitrary setting value.
	Moving average function	The moving average of the sampling pulse number that is loaded for each count cycle is processed for the specified number of times to calculate the mean value.
	Warning output function	Outputs a warning when the sampling pulse number enters the preset warning output range.
Counter reset function		Resets the sampling pulse number, accumulating count value, and input pulse value. These counters can be reset at an arbitrary timing. The accumulating count value can be preset to the specified value.
Interrupt function		Executes an interrupt program of the CPU module when an interrupt factor such as an error or warning output is detected.
Error history function		Stores up to 16 errors and alarms that occurred in the pulse input module in the buffer memory areas.
Event history function		Collects the errors and alarms that occurred and the operations executed in the pulse input module as event information into the CPU module.
Q compatible mode function		Assigns the buffer memory addresses of the pulse input module in the same way as those of the MELSEC-Q series module. The sequence program that has already been used for the MELSEC-Q series module can be used.
Online module change		Allows module replacement without stopping the system. For the procedure of the online module change, refer to the following.  MELSEC iQ-R Online Module Change Manual

# MEMO

---

# 4 PROCEDURES BEFORE OPERATION

---

This chapter describes the procedures before operation.

## 1. Mounting a module

Mount the pulse input module in any desired configuration.

## 2. Wiring

Perform wiring of external devices to the pulse input module.

 Page 26 External Wiring

## 3. Adding a module

Add the pulse input module to a module configuration by using the engineering tool. For details, refer to the following.

 GX Works3 Operating Manual

## 4. Making parameter settings

Set the parameters of the pulse input module by using the engineering tool. For details, refer to the following.

 MELSEC iQ-R Channel Isolated Pulse Input Module User's Manual (Application)

## 5. Programming

Create a program. For details, refer to the following.

 Page 29 OPERATION EXAMPLES

# MEMO

---

# 5 SYSTEM CONFIGURATION

---

For the system configuration of the MELSEC iQ-R series, CPU modules that can use the pulse input module, and the number of mountable modules, refer to the following.

 MELSEC iQ-R Module Configuration Manual





# 6 INSTALLATION AND WIRING

This chapter describes the installation and wiring of the pulse input module.

## 6.1 Wiring

This section describes the procedure to connect a pulse generator to the pulse input module.

### Wiring precautions

To configure a highly reliable system and to make full use of functions of the pulse input module, the external wiring must be unsusceptible to noise.

The following shows precautions for connecting the pulse generator.

#### Wiring

- Use different cables for the AC control circuit and the external input signal of the pulse input module so that the pulse input module is not affected by surge or induction on the AC side.
- Do not place or tie the cables together with the main circuit line, high voltage line, or load cable from the device other than the programmable controller. Leave sufficient space from the high voltage line or the circuit that involves high frequency such as the load main circuit of the inverter. Failure to do so may cause the module to be affected by noise, surge, and induction.
- Check the rated voltage and terminal layout before wiring to the pulse input module, and connect the cables correctly. Input of voltage beyond the rating or incorrect wiring may cause fire or failure.
- Do not apply a voltage to the input terminal that is higher than that specified in "Input voltage selection" of "Module parameter". Doing so may cause fire or failure of the module. For details on the module parameter, refer to MELSEC iQ-R Channel Isolated Pulse Input Module User's Manual (Application).

#### Measures to reduce noise

The pulse input module may malfunction if a pulsing noise is input. Take the following measures to reduce noise.

- Use a shielded twisted pair cable.
- Do not place the shielded twisted pair cable in parallel with a noisy power cable or I/O cable. Leave a space of at least 150mm from those cables. Connect modules at the shortest distance possible.
- Ground the shield wire with a ground resistance of 100 ohms or less.
- Ground the FG terminal of the pulse input module and the power supply module.

# Terminal block

## Precautions

- Tighten the module fixing screws and other screws within the specified torque range.

Screw type	Tightening torque range
Module fixing screw (M3) <sup>*1</sup>	0.37 to 0.48N-m
Terminal screw (M3)	0.42 to 0.58N-m
Terminal block mounting screw (M3.5)	0.66 to 0.89N-m

\*1 The hook on the top of the module allows the module to be fixed to a base unit easily. In a place where there is a lot of vibration, however, fixing with module fixing screws is recommended.

- The following table lists an applicable solderless terminal to be connected to the terminal block. When wiring, use the applicable wire and tightening torque in the table. Use UL listed solderless terminals and, for processing, use the tools recommended by their manufacturer. Note that a solderless terminal with an insulation sleeve cannot be used.

Solderless terminal		Wire			
Model	Applicable tightening torque	Diameter	Type	Material	Temperature rating
R1.25-3	0.42 to 0.58N-m	0.3 to 0.75mm <sup>2</sup> (AWG22 to 18)	Stranded wire	Copper wire	75°C or higher

## Signal names of the terminal block

The following table shows signal names of the terminal block.

Terminal block	Terminal number	Signal name
	1	CH1 V+
	2	CH1 V-
	3	CH2 V+
	4	CH2 V-
	5	CH3 V+
	6	CH3 V-
	7	CH4 V+
	8	CH4 V-
	9	CH5 V+
	10	CH5 V-
	11	CH6 V+
	12	CH6 V-
	13	CH7 V+
	14	CH7 V-
	15	CH8 V+
	16	CH8 V-
	17	FG
	18	FG

### Point

Terminal blocks that have been used on MELSEC-Q series channel isolated pulse input modules can be used just the way they are. The terminal layout is the same as that of the QD60P8-G.

The terminal blocks for MELSEC-L series terminal blocks, however, cannot be used because of the shape difference.

## Interface with external devices

The following table lists the external device interfaces of the pulse input module.

Input/output	Internal circuit	Terminal number	Signal name	Operation	Input voltage (guaranteed value)	Operating current (guaranteed value)	
Input		1, 3, 5, 7, 9, 11, 13, 15	CH1 to CH8 V+	When the signal is on	5VDC <sup>*1</sup> 12 to 24VDC <sup>*1</sup>	3.5 to 5.5V 4mA or higher 10.2 to 30V 4mA or higher	
		2, 4, 6, 8, 10, 12, 14, 16	CH1 to CH8 V-	When the signal is off	5VDC <sup>*1</sup> 12 to 24VDC <sup>*1</sup>	1.0V or lower 0.5mA or lower 2.0V or lower 0.5mA or lower	
		—	—	—	—	—	—
		—	—	—	—	—	—
—	—	17, 18	FG	—	—	—	

\*1 5VDC/12 to 24VDC can be switched in "Input voltage selection" of "Module parameter".

## 6.2 External Wiring

### Wiring to the terminal block

The following figures show wiring to the terminal block.

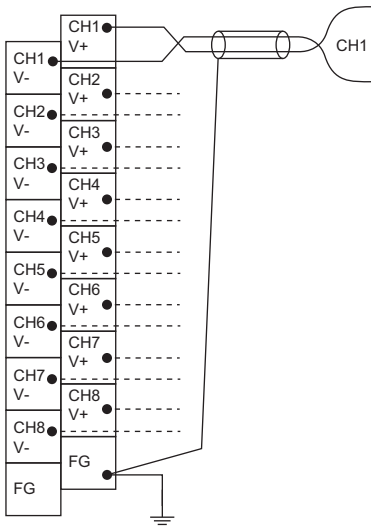

# Wiring examples of source-type pulse generator

The following figures show the wiring examples of the source-type pulse generator. The examples show wiring that connects the pulse generator only to CH1. In the examples, the voltage of the external power supply connected to the pulse generator is 24VDC.



Ground the FG terminal of the power supply module.

## Transistor output

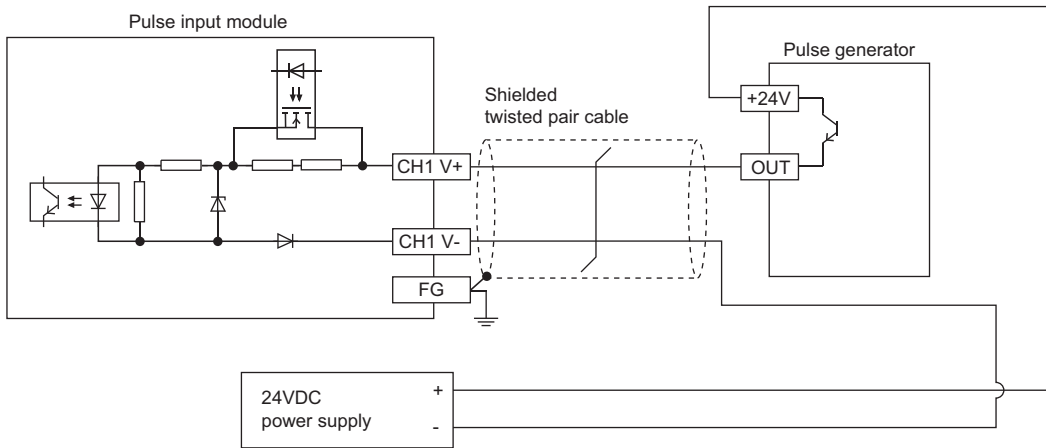

## Contact output

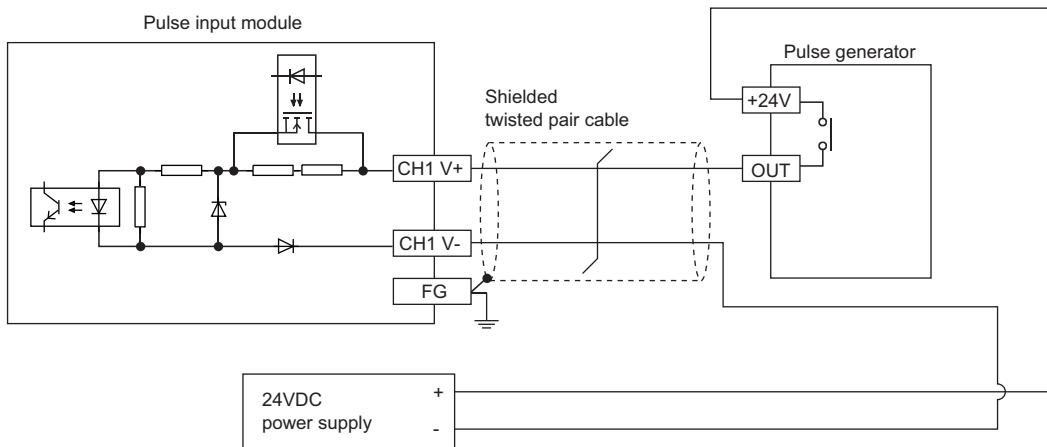

# Wiring examples of sink-type pulse generator

The following figures show wiring to the sink-type pulse generator. The examples show wiring that connects the pulse generator only to CH1. In the examples, the voltage of the external power supply connected to the pulse generator is 24VDC.

**Point**

Ground the FG terminal of the power supply module.

## Transistor output

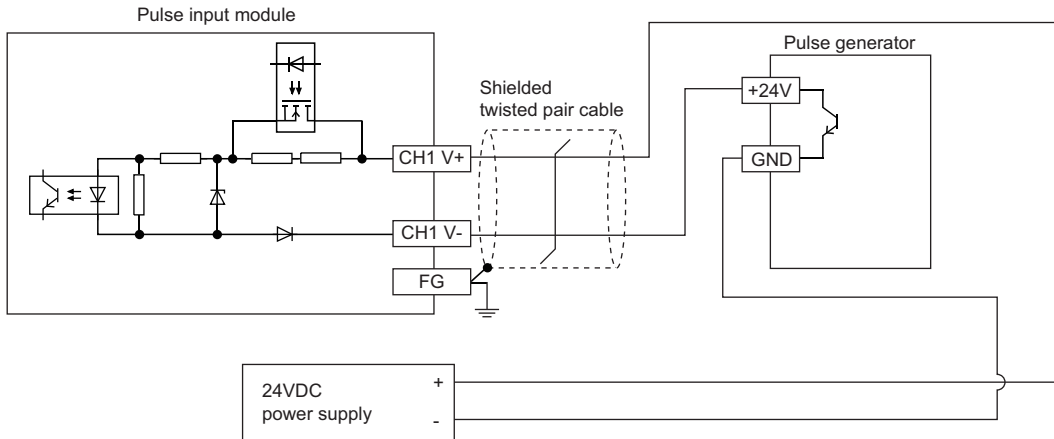

## Contact output

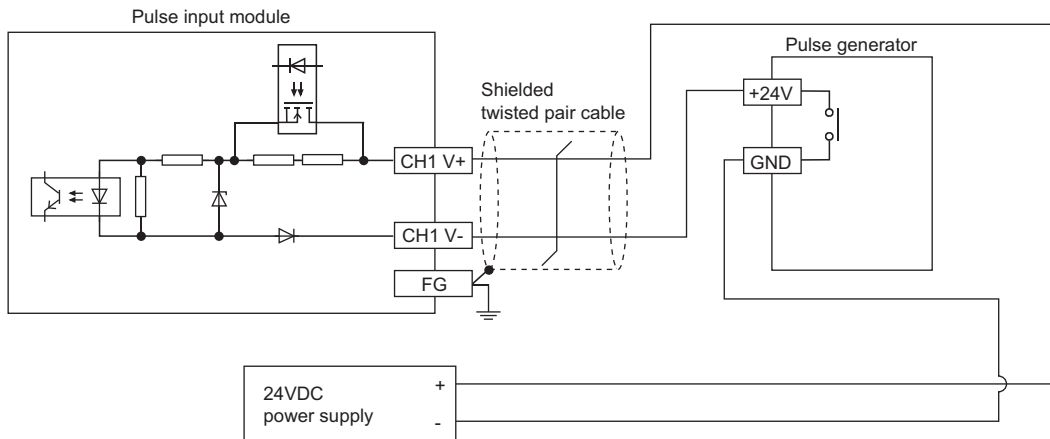

# 7 OPERATION EXAMPLES

---

This chapter describes the programming procedure and the basic program of the pulse input module.

## 7.1 Programming Procedure

---

Take the following steps to create a program for running the pulse input module:

**1.** Set parameters.

☞ Page 30 Parameter settings

**2.** Create a program.

☞ Page 32 Program examples

## 7.2 Program Examples

### System configuration

The following figure shows an example of the system configuration.

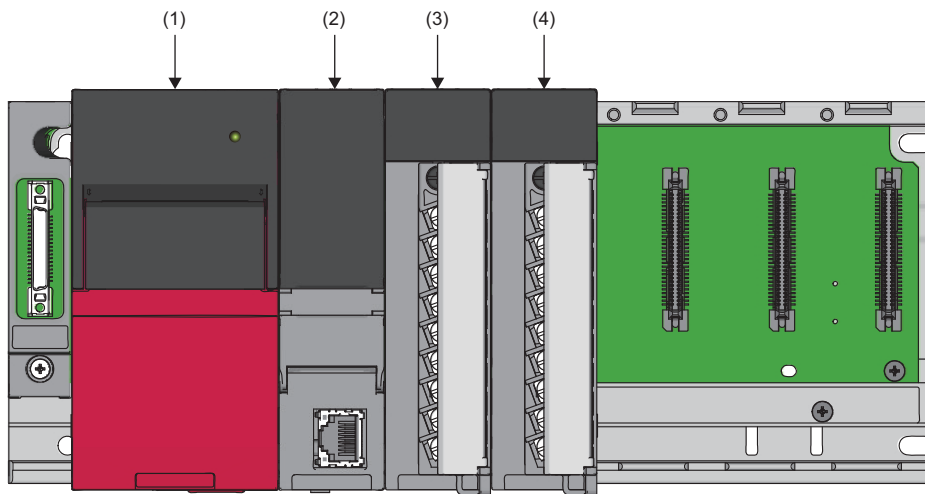

- (1) Power supply module (R61P)
- (2) CPU module (R04CPU)
- (3) Pulse input module (RD60P8-G)
- (4) Input module (RX10)

### Program conditions

This example shows a program that counts the pulses input to CH1 of the pulse input module.

### Parameter settings

Make the initial settings in the module parameter of the engineering tool. The auto refresh setting does not need to be changed here.

For details on the parameter settings, refer to the following.

MELSEC iQ-R Channel Isolated Pulse Input Module User's Manual (Application)

Function	Setting item	Setting value of CH1
Input voltage selection	Input voltage selection	0: 12 to 24VDC
Pulse edge selection	Pulse edge selection	0: Pulse up edge
Linear counter/ring counter selection	Linear counter/ring counter selection	0: Linear counter
Input filter setting	Input filter setting	0: 30kpps
Comparison output function	Comparison output selection	1: Comparison output function valid
	Comparison output setting value	500000
Pre-scale function	Pre-scale function selection	3: $\times 0.01$
	Pre-scale setting value	252
Moving average function	Moving average processing selection	1: Moving average processing
	Number of times of moving average processing	10 times
Count cycle change function	Count cycle change function selection	0: Count cycle change function invalid
	Count cycle setting value	0: 1s
Warning output function	Warning output selection	1: Warning output function valid
	Warning output setting value upper/upper limit	1100
	Warning output setting value upper/lower limit	1000
	Warning output setting value lower/upper limit	600
Counter reset function	Warning output setting value lower/lower limit	500
	Preset setting value for accumulating count value	0

Set default values for the parameters of CH2 to CH8.



## Label settings

GX Works3 provides functions that support the creation of a program.

The following table lists the module labels and global labels used for the program examples in this section.

Module label settings do not need to be changed. For details on the global labels, refer to the following.

 MELSEC iQ-R Programming Manual (Program Design)

Classification	Label name	Description	Device	
Module label	RD60P8G_1.bModuleREADY	Module READY	X0	
	RD60P8G_1.bOperatingConditionSettingCompleteFlag	Operating condition setting complete flag	X1	
	RD60P8G_1.bnErrorOccurrence[0]	CH1 Error occurrence	X8	
	RD60P8G_1.bnAccumulatingCounterComparisonFlag[0]	CH1 Accumulating counter comparison flag	X10	
	RD60P8G_1.bnErrorResetRequest[0]	CH1 Error reset request	Y8	
	RD60P8G_1.bnComparisonSignalResetRequest[0]	CH1 Comparison signal reset request	Y10	
	RD60P8G_1.bnCountEnable[0]	CH1 Count enable	Y18	
	RD60P8G_1.stnMonitor1[0].uSamplingPulseNumber	CH1 sampling pulse number	—	
	RD60P8G_1.stnMonitor1[0].udAccumulatingCountValue	CH1 accumulating count value	—	
	RD60P8G_1.stnMonitor1[0].udInputPulseValue	CH1 input pulse value	—	
	RD60P8G_1.stnMonitor1[0].uOverflowDetectionFlag	CH1 overflow detection flag	—	
	RD60P8G_1.stnMonitor1[0].uCarryOverDetectionFlag	CH1 carry over detection flag	—	
	RD60P8G_1.stnMonitor1[0].uErrorCode	CH1 error code	—	
	RD60P8G_1.stnMonitor1[0].uAlarmCode	CH1 alarm code	—	
	RD60P8G_1.stnControl_D[0].uCounterResetRequest_D	CH1 counter reset request	—	
RD60P8G_1.stnControl_D[0].uCarryOverResetRequest_D	CH1 carry over reset request	—		
Labels to be defined	Define global labels as shown below:			
	Label Name	Data Type	Class	Assign (Device/Label) /
1	OverflowDetectionFlag	Word [Unsigned]/Bit String [16-bit]	VAR_GLOBAL	
2	CounterResetting	Bit	VAR_GLOBAL	
3	CarryOverDetectionFlag	Word [Unsigned]/Bit String [16-bit]	VAR_GLOBAL	
4	CarryOverResetting	Bit	VAR_GLOBAL	
5	SamplingPulseNumber	Word [Unsigned]/Bit String [16-bit]	VAR_GLOBAL	
6	AccumulatingCountValue	Double Word [Unsigned]/Bit String [32-bit]	VAR_GLOBAL	
7	InputPulseValue	Double Word [Unsigned]/Bit String [32-bit]	VAR_GLOBAL	
8	ErrorCode	Word [Unsigned]/Bit String [16-bit]	VAR_GLOBAL	
9	AlarmCode	Word [Unsigned]/Bit String [16-bit]	VAR_GLOBAL	
10	CountEnableOnCommand	Bit	VAR_GLOBAL	X21
11	CountEnableOffCommand	Bit	VAR_GLOBAL	X22
12	ComparisonSignalResetCommand	Bit	VAR_GLOBAL	X23
13	ErrorResetCommand	Bit	VAR_GLOBAL	X24
14	CounterResetRequestCommand	Bit	VAR_GLOBAL	X25
15	SamplingPulseNumberReadCommand	Bit	VAR_GLOBAL	X26
16	AccumulatingCountValueReadCommand	Bit	VAR_GLOBAL	X27
17	InputPulseValueReadCommand	Bit	VAR_GLOBAL	X28

## Program examples

### Program example 1

This example shows a program that starts the count operation when CH1 Count enable is turned on and stops when CH1 Count enable is turned off.

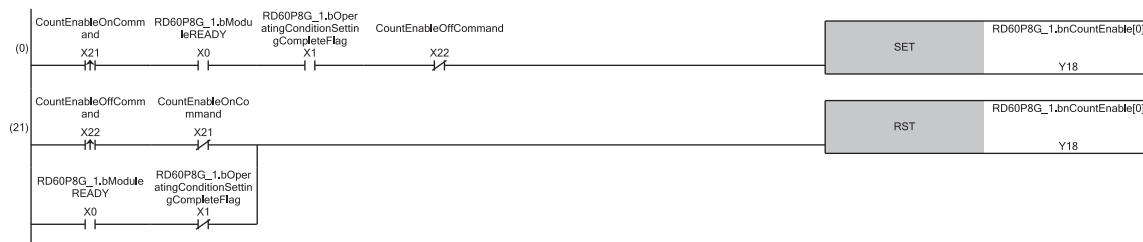

(0) 'CH1 Count enable' (Y18) is turned on.

(21) 'CH1 Count enable' (Y18) is turned off.

### Program example 2

This example shows a program that resets CH1 Accumulating counter comparison flag.

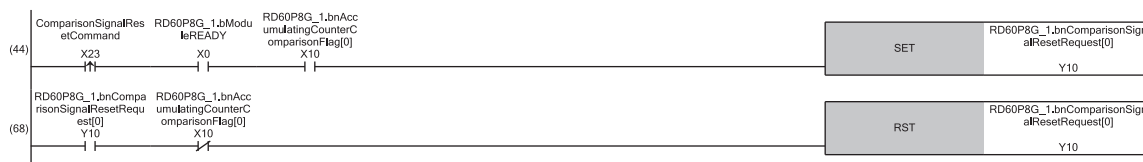

(44) 'CH1 Comparison signal reset request' (Y10) is turned on.

(68) 'CH1 Comparison signal reset request' (Y10) is turned off.

### Program example 3

This example shows a program that resets an error or alarm.

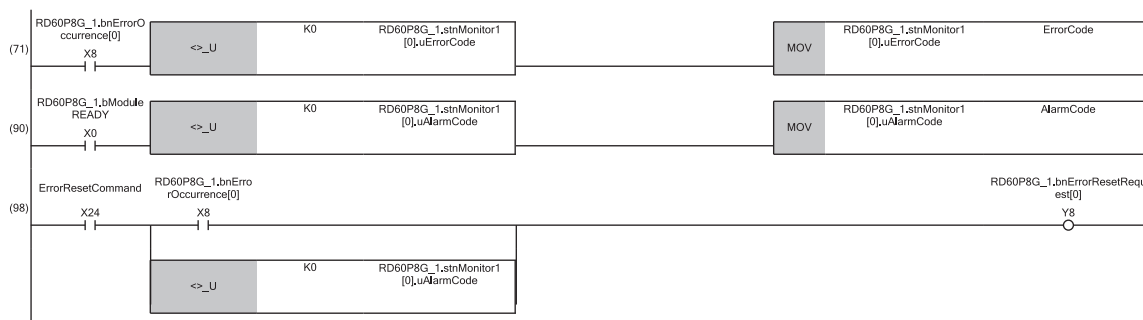

(71)'CH1 Error code' (Un\G9) is read. It is held even after the error is reset.

(90)'CH1 Alarm code' (Un\G10) is read. It is held even after the error is reset.

(98) 'CH1 Error reset request' (Y8) is turned on.

### Program example 4

This example shows a program that resets the CH1 sampling pulse number, CH1 accumulating count value, and CH1 input pulse value.

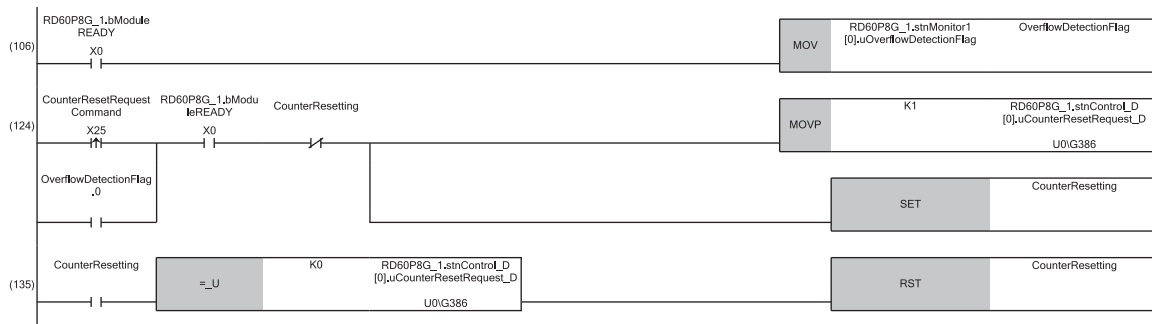

(106)'CH1 Overflow detection flag' (Un\G6) is read.

(124)Reset request (1) is stored in 'CH1 Counter reset request' (Un\G386). 'Counter resetting' is turned on.

(135) 'Counter resetting' is turned off.

### Program example 5

This example shows a program that resets CH1 Carry over detection flag.

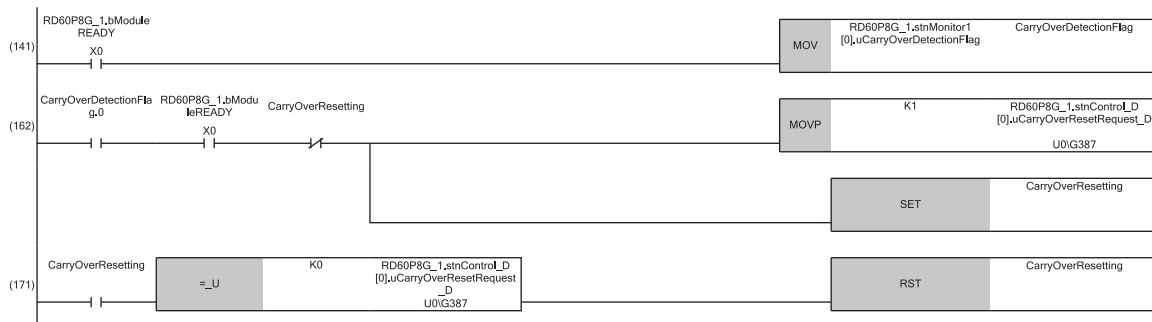

(141) 'CH1 Carry over detection flag' (Un\G7) is read.

(162) Reset request (1) is stored in 'CH1 Carry over reset request' (Un\G387). 'Carry over resetting' is turned on.

(171)'Carry over resetting' is turned off.

### Program example 6

This example shows a program that reads CH1 sampling pulse number.



(177) 'CH1 Sampling pulse number' (Un\G0) is read.

### Program example 7

This example shows a program that reads CH1 accumulating count value.



(200) 'CH1 Accumulating count value' (Un\G2, Un\G3) is read.

### Program example 8

This example shows a program that reads CH1 input pulse value.



(220)'CH1 Input pulse value' (Un\G4, Un\G5) is read.

# APPENDICES

## Appendix 1 External Dimensions

The following figure shows the external dimensions of the pulse input module.

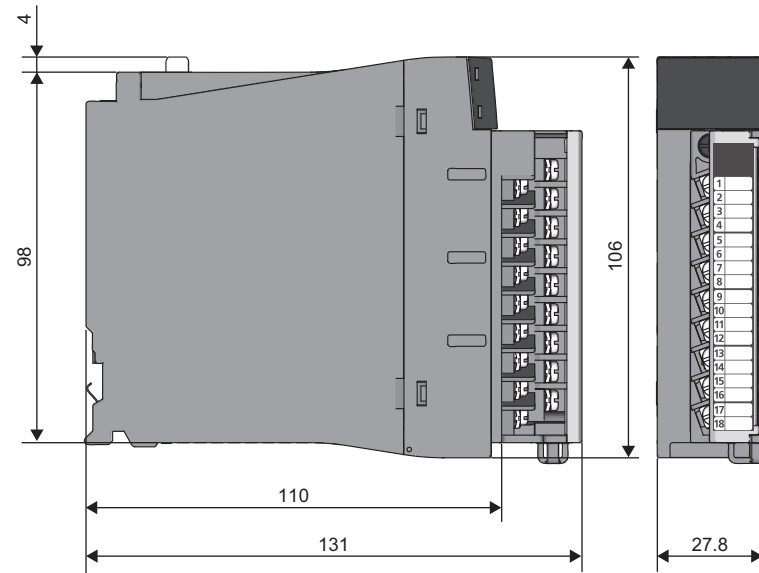

(Unit: mm)

# MEMO

---

A

# INDEX

---

## A

---

ALM LED . . . . . 13

## B

---

Buffer memory . . . . . 12

## C

---

CH1 to CH8 LED . . . . . 13

## E

---

Engineering tool . . . . . 12  
ERR LED . . . . . 13  
External device interface . . . . . 25  
External dimensions . . . . . 34  
External wiring . . . . . 26

## G

---

Global label . . . . . 12

## M

---

Measures to reduce noise . . . . . 23  
Module label . . . . . 12

## P

---

Performance specifications . . . . . 15  
Production information marking . . . . . 13  
Program examples . . . . . 30  
Pulse input module . . . . . 12

## Q

---

Q series-compatible mode . . . . . 12

## R

---

R mode . . . . . 12  
RUN LED . . . . . 13

## S

---

Signal names of the terminal block . . . . . 24

## T

---

Terminal block . . . . . 13,24

## W

---

Watchdog timer error . . . . . 12

# MEMO

---

# REVISIONS

---

\*The manual number is given on the bottom left of the back cover.

Revision date	*Manual number	Description
October 2018	SH(NA)-082003ENG-A	First edition

Japanese manual number: SH-082002-A

---

This manual confers no industrial property rights of any other kind, nor does it confer any patent licenses. Mitsubishi Electric Corporation cannot be held responsible for any problems involving industrial property rights which may occur as a result of using the contents noted in this manual.

---

© 2018 MITSUBISHI ELECTRIC CORPORATION



# WARRANTY

---

Please confirm the following product warranty details before using this product.

## **1. Gratis Warranty Term and Gratis Warranty Range**

If any faults or defects (hereinafter "Failure") found to be the responsibility of Mitsubishi occurs during use of the product within the gratis warranty term, the product shall be repaired at no cost via the sales representative or Mitsubishi Service Company.

However, if repairs are required onsite at domestic or overseas location, expenses to send an engineer will be solely at the customer's discretion. Mitsubishi shall not be held responsible for any re-commissioning, maintenance, or testing on-site that involves replacement of the failed module.

[Gratis Warranty Term]

The gratis warranty term of the product shall be for one year after the date of purchase or delivery to a designated place. Note that after manufacture and shipment from Mitsubishi, the maximum distribution period shall be six (6) months, and the longest gratis warranty term after manufacturing shall be eighteen (18) months. The gratis warranty term of repair parts shall not exceed the gratis warranty term before repairs.

[Gratis Warranty Range]

- (1) The range shall be limited to normal use within the usage state, usage methods and usage environment, etc., which follow the conditions and precautions, etc., given in the instruction manual, user's manual and caution labels on the product.
- (2) Even within the gratis warranty term, repairs shall be charged for in the following cases.
  1. Failure occurring from inappropriate storage or handling, carelessness or negligence by the user. Failure caused by the user's hardware or software design.
  2. Failure caused by unapproved modifications, etc., to the product by the user.
  3. When the Mitsubishi product is assembled into a user's device, Failure that could have been avoided if functions or structures, judged as necessary in the legal safety measures the user's device is subject to or as necessary by industry standards, had been provided.
  4. Failure that could have been avoided if consumable parts (battery, backlight, fuse, etc.) designated in the instruction manual had been correctly serviced or replaced.
  5. Failure caused by external irresistible forces such as fires or abnormal voltages, and Failure caused by force majeure such as earthquakes, lightning, wind and water damage.
  6. Failure caused by reasons unpredictable by scientific technology standards at time of shipment from Mitsubishi.
  7. Any other failure found not to be the responsibility of Mitsubishi or that admitted not to be so by the user.

## **2. Onerous repair term after discontinuation of production**

- (1) Mitsubishi shall accept onerous product repairs for seven (7) years after production of the product is discontinued. Discontinuation of production shall be notified with Mitsubishi Technical Bulletins, etc.
- (2) Product supply (including repair parts) is not available after production is discontinued.

## **3. Overseas service**

Overseas, repairs shall be accepted by Mitsubishi's local overseas FA Center. Note that the repair conditions at each FA Center may differ.

## **4. Exclusion of loss in opportunity and secondary loss from warranty liability**

Regardless of the gratis warranty term, Mitsubishi shall not be liable for compensation to:

- (1) Damages caused by any cause found not to be the responsibility of Mitsubishi.
- (2) Loss in opportunity, lost profits incurred to the user by Failures of Mitsubishi products.
- (3) Special damages and secondary damages whether foreseeable or not, compensation for accidents, and compensation for damages to products other than Mitsubishi products.
- (4) Replacement by the user, maintenance of on-site equipment, start-up test run and other tasks.

## **5. Changes in product specifications**

The specifications given in the catalogs, manuals or technical documents are subject to change without prior notice.

# TRADEMARKS

---

The company names, system names and product names mentioned in this manual are either registered trademarks or trademarks of their respective companies.

In some cases, trademark symbols such as <sup>™</sup> or <sup>®</sup> are not specified in this manual.



SH(NA)-082003ENG-A(1810)MEE

MODEL: RD60P8-G-U-IN-E

MODEL CODE: 13JX89

## **mitsubishi electric corporation**

HEAD OFFICE : TOKYO BUILDING, 2-7-3 MARUNOUCHI, CHIYODA-KU, TOKYO 100-8310, JAPAN  
NAGOYA WORKS : 1-14, YADA-MINAMI 5-CHOME, HIGASHI-KU, NAGOYA, JAPAN

When exported from Japan, this manual does not require application to the  
Ministry of Economy, Trade and Industry for service transaction permission.

Specifications subject to change without notice.